

Instructions

Matrix Switcher Card Cage

Model No. **WJ-SX850**

Before attempting to connect or install this product, please read these instructions carefully and save this manual for future use.



SA 1965

The lightning flash with arrowhead symbol, within an equilateral triangle, is intended to alert the user to the presence of uninsulated "dangerous voltage" within the product's enclosure that may be of sufficient magnitude to constitute a risk of electric shock to persons.



SA 1966

The exclamation point within an equilateral triangle is intended to alert the user to the presence of important operating and maintenance (servicing) instructions in the literature accompanying the appliance.

For U.S.A.

NOTE: This equipment has been tested and found to comply with the limits for a Class A digital device, pursuant to Part 15 of the FCC Rules. These limits are designed to provide reasonable protection against harmful interference when the equipment is operated in a commercial environment. This equipment generates, uses, and can radiate radio frequency energy and, if not installed and used in accordance with the instruction manual, may cause harmful interference to radio communications.

Operation of this equipment in a residential area is likely to cause harmful interference in which case the user will be required to correct the interference at his own expense.

FCC Caution: To assure continued compliance, (example - use only shielded interface cables when connecting to computer or peripheral devices). Any changes or modifications not expressly approved by the party responsible for compliance could void the user's authority to operate this equipment.

The serial number of this product may be found on the left of the unit.

You should note the serial number of this unit in the space provided and retain this book as a permanent record of your purchase to aid identification in the event of theft.

Model No. _____

Serial No. _____

WARNING:

To reduce the risk of fire or electric shock, do not expose this appliance to rain or moisture.

■ Preface

The WJ-SX850 is a card cage designed to allow flexible system expansion of the System 850 Matrix Switcher. It is provided with a power supply for the boards installed, and a Local CPU board to control boards in the cage.

■ Appearance

● Front View

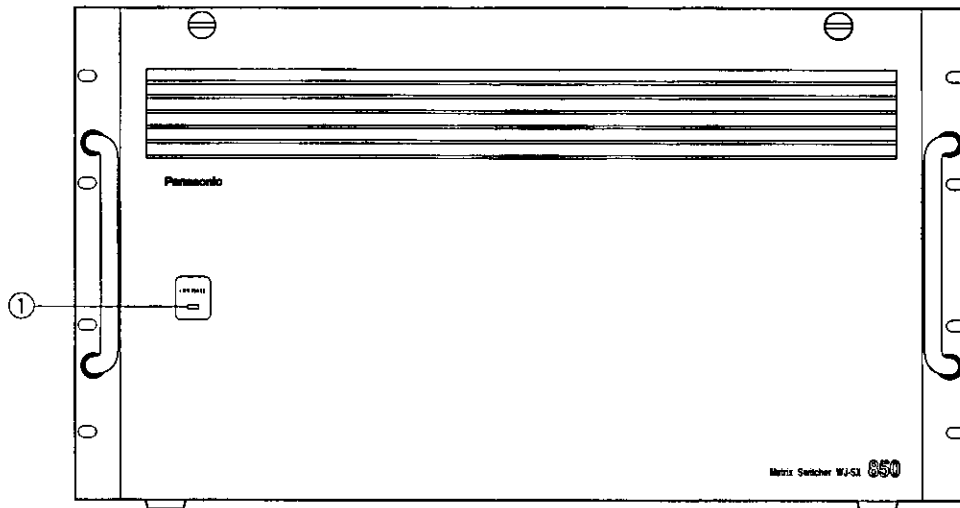

● Rear View

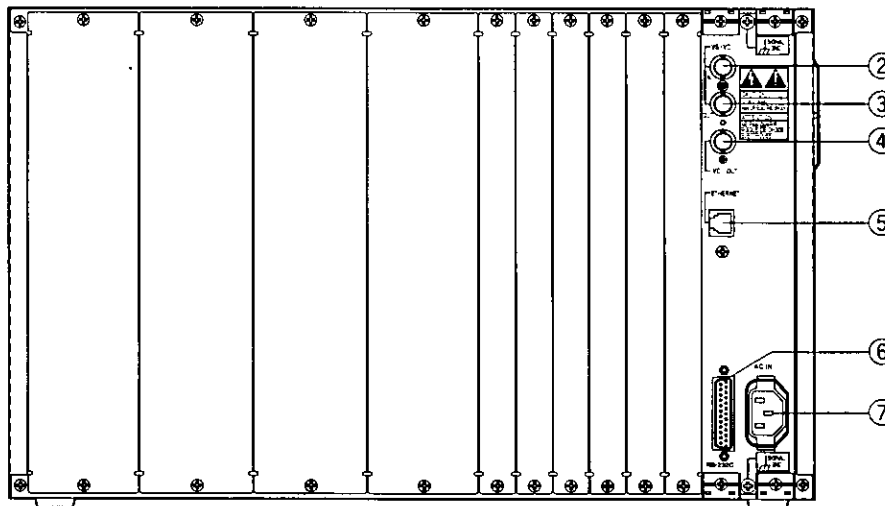

① Operate Indicator (OPERATE)

Is on when the power of the WJ-SX850 Matrix Switcher Card Cage is turned on.

Note: The power switch of this cage is located underneath the front panel.

Remove the front panel by removing two screws on the panel.

② VS/VD Input Connector (VS/VD IN)

Accepts either the VD (Vertical Drive) pulse or the VS (Video Sync) signal for synchronizing the system.

Notes:

- This input is looped through to the VS/VD Output Connector.
- When the VD (or VS) signal is supplied to the VS/VD Input Connector, turn the VS/VD selection switch (SW7) on the circuit board to the VD (or VS) position. The factory default setting of the VS/VD selection switch (SW7) is VD. Ask qualified service personnel about setting up this switch.
- The external sync signal should meet EIA RS-170 specifications and should not contain any jitters, such as a VCR playback signal.

③ **VS/VD Output Connector (VS/VD OUT)**

Outputs either the VD (Vertical Drive) pulse or the VS (Video Sync) signal for synchronizing other system components.

Note: The input at the VS/VD Input Connector is looped through to this output. These inputs and outputs are connected internally.

④ **VD Output Connector (VD OUT)**

Outputs VD (Vertical Drive) pulses for synchronizing other system components.

Notes:

- The internal VD pulse or the looped-through external VD pulse is provided at this connector.
- When the VS signal is supplied to the VS/VD Input Connector, the VD output signal from the VD Output Connector will be delayed by approximately 15 μ s with respect to the V-sync of the VS input signal.

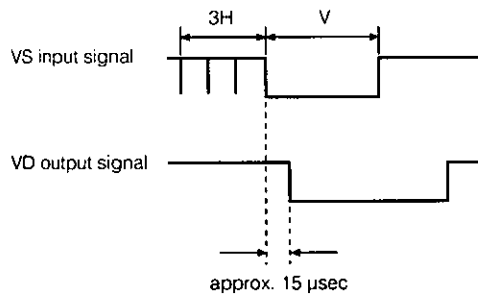

⑤ **Ethernet Port (ETHERNET)**

For exchanging control data with the Central Processing Unit (CPU) via Ethernet.

⑥ **RS-232C Port (RS-232C)**

This port is used only for factory tests.

⑦ **AC Inlet Socket (AC IN)**

Plug the power cord (supplied as a standard accessory) into this socket and connect the cord to an AC outlet.

Board Setting

The following settings should be made by qualified service personnel or system installers.

1. Remove the front panel by removing two screws on the panel.

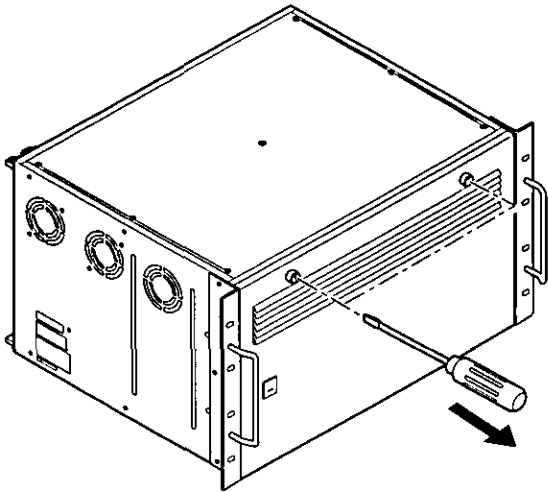

2. Extract the Local CPU board by raising up the card puller.

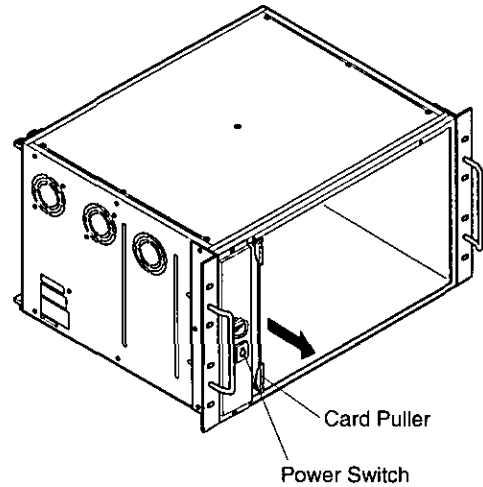

Caution

Hold this board only by its edges. Otherwise components on the board may be damaged by static electricity.

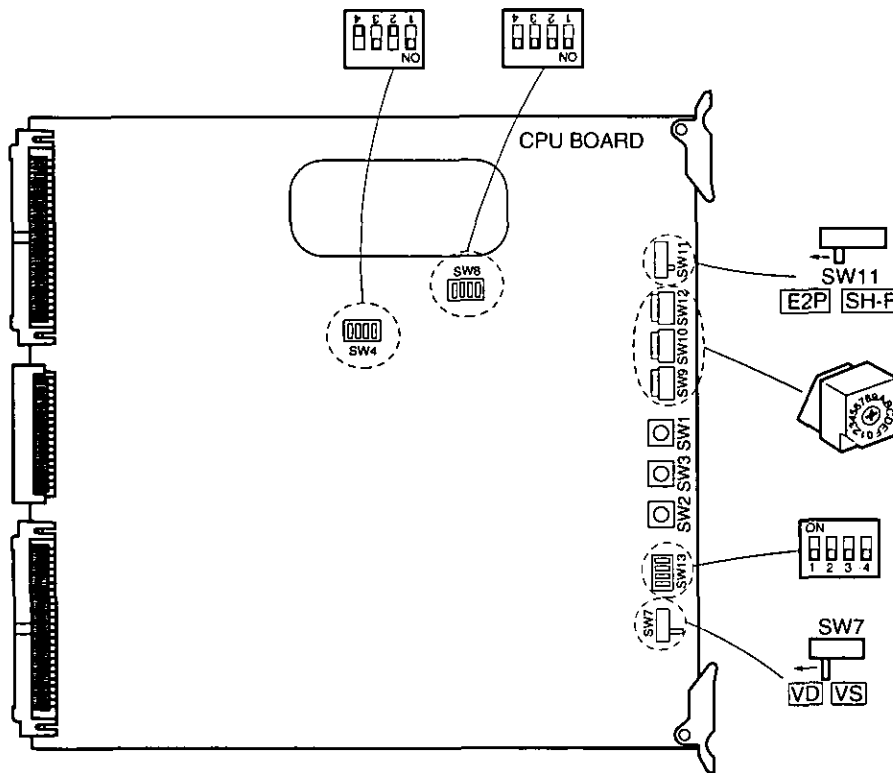

SW1: Factory use only
 SW3: LCPU Reset Switch
 SW2: Cord Cage Reset Switch

3. Set switches (SW9, SW10 and SW12) on the board to designate the cage number as shown below. The cage number and corresponding switch settings are given in the following address table. The factory default setting is 000.

Cage No.	SW Setting			Cage No.	SW Setting		
	SW12	SW10	SW9		SW12	SW10	SW9
1	0	0	1	16	0	1	1
2	0	0	2	17	0	1	2
3	0	0	3	18	0	1	3
4	0	0	4	19	0	1	4
5	0	0	5	20	0	1	5
6	0	0	6	21	0	1	6
7	0	0	7	22	0	1	7
8	0	0	8	23	0	1	8
9	0	0	9	24	0	1	9
10	0	0	A	25	0	1	A
11	0	0	B	26	0	1	B
12	0	0	C	27	0	1	C
13	0	0	D	28	0	1	D
14	0	0	E	29	0	1	E
15	0	0	F	30	0	1	F
241	1	0	1	256	1	1	1
242	1	0	2	257	1	1	2
243	1	0	3	258	1	1	3
244	1	0	4	259	1	1	4
245	1	0	5	260	1	1	5
246	1	0	6	261	1	1	6
247	1	0	7	262	1	1	7
248	1	0	8	263	1	1	8
249	1	0	9	264	1	1	9
250	1	0	A	265	1	1	A
251	1	0	B	266	1	1	B
252	1	0	C	267	1	1	C
253	1	0	D	268	1	1	D
254	1	0	E	269	1	1	E
255	1	0	F	270	1	1	F

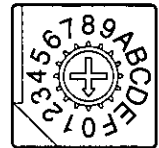

Designate further cage numbers, referring to the above address table. Cage numbers are available up to 1 024.

5. Confirm that switch (SW11) on the board is set to **E2P** position.

4. Set switch (SW7) on the board to select either VD or VS for the Sync input signal, if applicable. The factory default setting is VD.

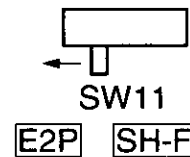
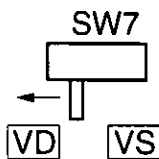

6. Confirm that switches (SW4, SW8 and SW13) on the board are set as follows:

7. Place the board into the CPU slot in the front of the cage by sliding it along the board guide.

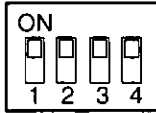

Switch Number	Setting Positions			
	1	2	3	4
SW4	ON	OFF	ON	OFF
SW8	ON	ON	ON	ON
SW13	OFF	OFF	OFF	OFF

DIP SW8	OFF	ON
1	PROM Mode	Normal Mode
4	MAC Address Write-enable Mode	Normal Mode

■ Specifications

Power Supply:	120 V AC 60 Hz
Power Consumption:	150 W (max. 150 W when all slots are occupied)
VS/VD Input/Output:	2 (BNC)
VD Output:	Video Level 4 V[p-p]/75 Ω (BNC)
Ethernet Port:	10Base-T, 8-conductor modular jack
RS-232C Port:	25-pin D-sub connector
Ambient Operating Temperature:	-10°C - +50°C (14°F - 122°F)
Ambient Operating Humidity:	Less than 90 %
Dimensions:	430 (W) x 265 (H) x 350 (D) mm 16-15/16" (W) x 10-7/16" (H) x 13-3/4 (D)
Weight:	13 kg (28.6 lbs)

Weight and dimensions indicated are approximate.
Specifications are subject to change without notice.

■ Accessory

Power Cord.....1 pc.

Panasonic Security and Digital Imaging Company

A Division of Matsushita Electric Corporation of America

Executive Office: One Panasonic Way 3E-7, Secaucus, New Jersey 07094

Regional Offices:

Northeast: One Panasonic Way, Secaucus, NJ 07094 (201) 348-7303

Southern: 1225 Northbrook Parkway, Suite 1-160, Suwanee, GA 30024 (770) 338-6838

Midwest: 1707 North Randall Road, Elgin, IL 60123 (847) 468-5211

Western: 6550 Katella Ave., Cypress, CA 90630 (714) 373-7840

Panasonic Canada Inc.

5770 Ambler Drive, Mississauga,
Ontario, L4W 2T3 Canada (905)624-5010

Panasonic Sales Company

Division of Matsushita Electric of Puerto Rico Inc.

Ave. 65 de Infanteria, Km. 9.5
San Gabriel Industrial Park, Carolina,
Puerto Rico 00985 (809)750-4300